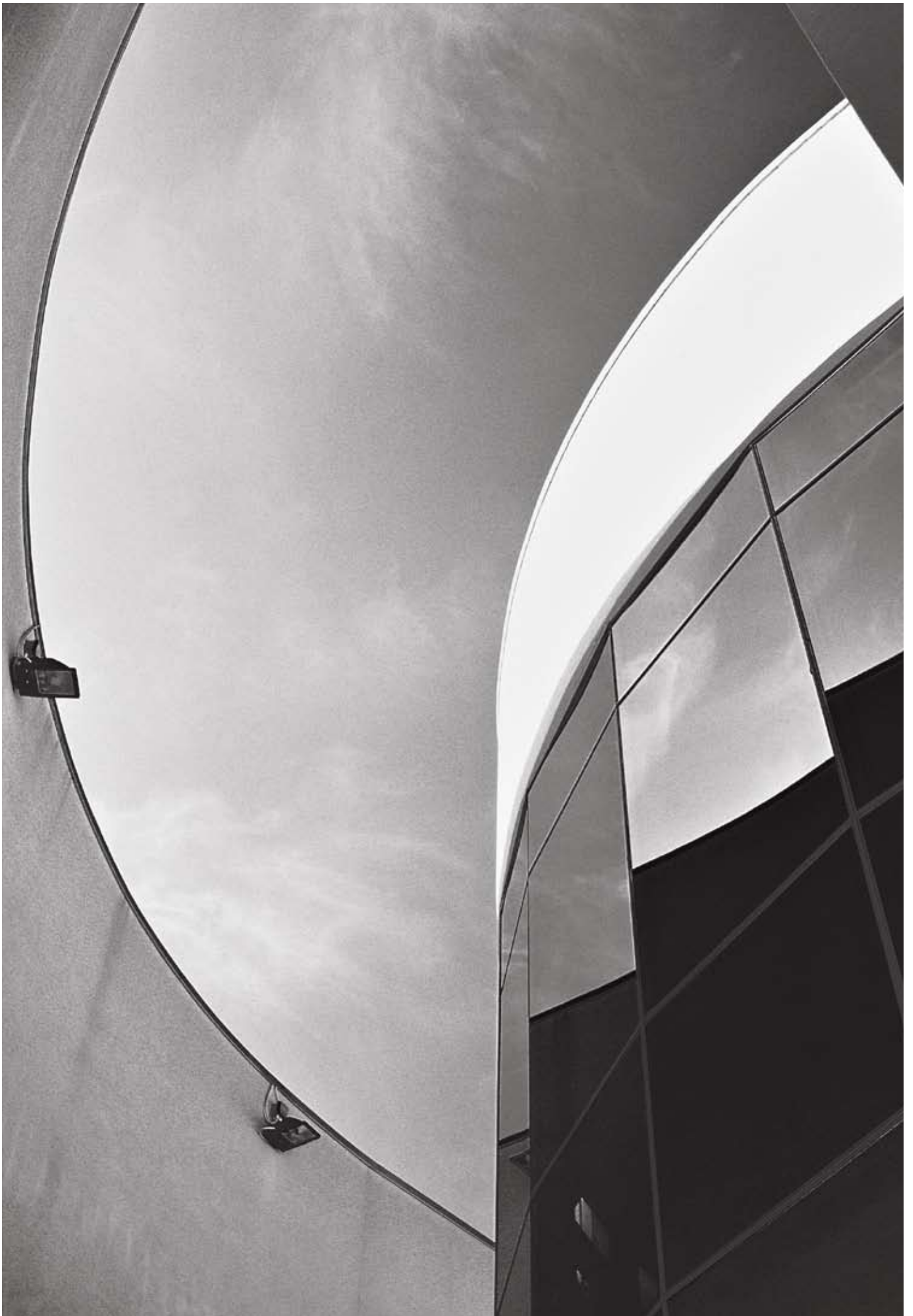


**PROGRAMMA
400 - HR**





ITALIANO

Se avete aperto una porta, vi siete affacciati su uno spettacolare vuoto urbano o vi è accaduto di attraversare ambienti liberi dagli irritanti intralci delle barriere architettoniche allora, avete impugnato una nostra idea. Siamo il brand dell'acciaio inox AISI 316L il più duro, resistente ed elastico tra gli acciai e della resina termoplastica poliammide 6, la più nobile. Sviluppiamo le nostre aree tematiche: le maniglie per porte e finestre, i maniglioni e i maniglioni con serratura, gli elementi per pareti divisorie, le balaustrate, le panchine ischiatiche e i supporti per il "vivere senza barriere", nella convinzione che gli oggetti dicano un ambiente, ne dichiarino il temperamento, le illusioni, le possibilità. Le forme "informano" e hanno effetti logici, modificano il mondo e dichiarano delle priorità. Per noi priorità è che - adesso - la bellezza è vera solo se si dà a tutti accessibile.

ENGLISH

If you've opened a door, you're bound to have seen a spectacular empty urban setting, or you may have strolled through environments free of annoying architectural barriers that block your way, and if you've done so – you've grasped our idea. We've made our name in AISI 316L stainless steel, the hardest, most resistant and elastic of steels, and in polyamide 6 thermoplastic resin, the noblest of plastics. We develop our themes: handles for doors and windows, pull handles, pull handles with lock, accessories for cubicles and partitions, balustrades, ischial support benches and supports for "living without barriers", convinced that objects create an environment, its temperament, illusions, and possibilities. Forms "inform" and have logical effects, changing the world and establishing priorities. For us the priority is that – here and now - beauty is only real if it is accessible to all.

FRANCAIS

S'il vous est arrivé d'ouvrir une porte pour vous pencher sur un vide urbain spectaculaire, ou si vous en avez eu l'occasion de parcourir des habitats libérés des obstacles irritants que représentent les barrières architecturales, alors vous avez pu saisir l'une de nos idées. Nous sommes la marque de l'acier inox AISI 316L le plus dur, le plus résistant et le plus élastique parmi les aciers, et de la résine thermoplastique polyamide 6, la plus noble. Nous développons nos différents thèmes: les poignées de portes et de fenêtres, les poignées de tirage et les poignées de tirage avec serrure, les accessoires pour cloisons, les garde-corps, les appuis ischiatiques et les supports afin de "vivre sans barrières", parce que nous sommes convaincus que les objets caractérisent un habitat en affirmant son tempérament, ses illusions et ses possibilités. Les formes "informent", elles ont des effets logiques, elles modifient le monde et déclarent des priorités. Pour nous, la priorité c'est que – maintenant – la beauté n'est authentique que si on la rend accessible à tous.

DEUTSCH

Wenn Sie eine Tür öffnen, erfahren Sie entweder trübes Einerlei oder es kann sein, dass Sie durch Räume gehen, die frei sind von irritierenden Hindernissen oder architektonischen Barrieren. Dann begegnen Sie unseren Ideen. Unser Werkstoff Edelstahl AISI 316L ist einer der härtesten, widerstandsfähigsten und elastischsten unter den Edelstählen; das von uns verarbeitete thermoplastische Kunstharz Polyamid 6 ist eines der hochwertigsten Kunststoffe, das verfügbar ist. Unsere Produktentwicklungen beziehen sich auf die Bereiche Tür- und Fenstergriffe, verschließbare Griffe, Zubehöre für Trennwandsysteme, Handläufe und Geländer, variable Anlehnhilfen sowie unterstützende Elemente für ein barrierefreies Leben. Wir sind davon überzeugt, dass unsere Produkte ein Ambiente erzeugen, dass dem Menschen die Möglichkeit gibt, sein Temperament, seine Träume und Fähigkeiten zu leben und zu entfalten.

Design und Funktion unserer Produkte sind logisch und sprechen für sich. Sie beeinflussen ihre Umgebung durch ihre Vorzüge.

ESPAÑOL

Si ha abierto una puerta, se ha asomado a una baranda que da a una espectacular vista urbana o ha cruzado por lugares libres de esos enervantes obstáculos que crean las barreras arquitectónicas... en ese caso, se ha aferrado a una de nuestras ideas. Somos la marca del acero inoxidable AISI 316L - el más duro, el más resistente y elástico de los aceros - y de la poliamida 6 - la más noble de las resinas termoplásticas -. Desarrollamos nuestras áreas temáticas: las manillas para puertas y ventanas, los manillones con cerradura, los accesorios para paredes divisorias y cabinas, las balaustradas, los apoyos isquiáticos y los soportes para una «vida sin barreras», convencidos como estamos de que los objetos hablan sobre un ambiente, declaran cuál es su temperamento, sus ilusiones, sus posibilidades. Las formas «informan» y tienen efectos lógicos, modifican el mundo y establecen prioridades. Nuestro pensamiento prioritario - ahora - es que la belleza es auténtica solamente cuando es accesible para todos.

NEDERLANDS

Als u een deur geopend hebt, als u zich voor een prachtige stadsleegte hebt bevonden, of als het u reeds overkomen is ruimtes te doorkruisen die vrij zijn van alle vervelende belemmeringen van architectonische barrières, dan zit u op onze golfengte. Wij zijn het merk van het roestvast staal AISI 316L, het hardste, meest bestendige en meest elastische van alle staalsoorten en van de thermoplastische polyamide 6, de nobelste van alle harssoorten. Wij ontwikkelen onze thema's: grepen voor deuren en vensters, voordeurgrepen en grepen met ingebouwde cilinders, de accessoires voor scheidingswanden en hokjes, de balustrades, de ischiatische zitbanken en steunen voor het "leven zonder barrières", volgens de overtuiging dat de voorwerpen een omgeving verhalen, het temperament, de illusies en de mogelijkheden ervan verklaren. De vormen "geven informatie" en hebben logische gevolgen, wijzigen de wereld en stellen prioriteiten. Prioriteit is voor ons dat – nu – de schoonheid slechts waarlijk is wanneer ze voor iedereen toegankelijk is.



PHOTO: Gabriele Basilico



**PROGRAMMA
400 - HR**



Pag. 10



Pag. 18



Pag. 10-11



Pag. 20



Pag. 11



Pag. 14



Pag. 14



Pag. 14-15



Pag. 15

ITALIANO
PROGRAMMA 400-HR

Prove certificate attestano la resistenza meccanica dei prodotti del Programma 400-HR. La progettazione per moduli permette soluzioni di assemblaggio in grado di soddisfare ogni tipologia di richiesta del progettista. I prodotti del Programma 400-HR sono disponibili anche nella versione conforme agli standard americani ADA.

Acciaio Inox AISI 316L

Finitura standard: satinata. Finitura a richiesta: lucida.

Legno

Verniciatura di serie. Verniciatura a campione.

ENGLISH
PROGRAMMA 400-HR

Certified by the most important international laboratories the Programma 400-HR products have been tested to the absolute resistance to mechanical stress. Modular design offers assembly solutions that can meet the designer's every need. The products of Program 400-HR are available also in conformance with the American Standards ADA.

Stainless Steel AISI 316L

Standard finish: satin. Finish on request: bright.

Wood

Standard finish. Custom finish.

FRANCAIS
PROGRAMMA 400-HR

Des essais certifiés attestent de la résistance mécanique des produits du Programme 400-HR. Le concept modulaire intuitif permet de trouver des solutions de montage à même de satisfaire tous les types d'exigences du concepteur. Les articles du Programme 400 HR sont disponibles dans les versions conformes aux standards US-ADA.

Acier Inoxydable AISI 316L

Finition standard satinée. Finition à la demande polie.

Bois

Teinte standard. Teinte sur échantillon.

DEUTSCH
PROGRAMMA 400-HR

Die wichtigsten internationalen Institute haben technische Prüfungen durchgeführt und bescheinigen die hervorragende mechanische Widerstandsfähigkeit der Produkte des Programms 400-HR. Die Planung mit modularen Elementen erlaubt Montagelösungen, die jeder Forderung nachkommen können. Die Produktpalette des Programmes 400-HR sind verfügbar konform des amerikanischen Standards ADA.

Edelstahl rostfrei Werkstoff 1.4404

Standardausführung: Matt satiniert. Auf Anfragh: polierte Ausführung.

Massivholz

Klarlack, mehrschichtung. Lackierung nach Farbmuster.

ESPAÑOL
PROGRAMMA 400-HR

Pruebas certificadas demuestran la absoluta resistencia mecánica de los productos del Programa HR. La realización mediante módulos, permite soluciones de ensamblaje capaces de satisfacer cada tipo de requerimiento del diseñador. Los artículos de el Programa 400-HR están disponibles en conformidad con las normativas americanas ADA.

Acero Inoxidable AISI 316L

Acabado estándar: satinado. Acabado a petición: brillante.

Madera

Barnizado en serie. Barnizado por muestra.

NEDERLAND
PROGRAMMA 400-HR

Testen garanderen de mechanische weerstand van alle producten van het programma HR. Het ontwerp in gemoduleerde elementen geeft oplossingen die in staat zijn om elke vraag van ieder ontwerp te beantwoorden. Alle artikelen uit het programma 400-HR zijn ook beschikbaar in de versie, conform aan de Amerikaanse veiligheidsnorm ADA.

Roestvast Staal AISI 316L

Standaarduitvoering: geborsteld. Op aanvraag: blinkend gepolijst.

Hout

Standaard gekleurd. Gekleurd volgens staal.

Nylon

Colori - Colours - Couleurs - Farbe - Colores - Kleuren



PROGRAMMA 400-HR
ITALIANO

Specifiche d'ordine	Finiture	Misura fatturabile
Per tutti gli articoli: Codice articolo Tipologia di finitura	Nylon .01 = Bianco .02 = Biscotto .03 = Giallo Pastello .04 = Giallo .05 = Blu Pastello .06 = Blu .07 = Grigio .08 = Verde .09 = Rosso .10 = Nero Acciaio Inox AISI 316 L .44 = Satinato .43 = Lucido Legno verniciatura di serie: Faggio verniciatura a campione: 📦	1 Metro lineare

Struttura codici articoli PBA

0 0 0	.	0 0 0	.	0 0 0 0	.	0 0
Programma		Codice Progressivo		Caratteristiche Tecniche		Finitura

In dotazione: curve con snodo. Escluso Programmi 400-HR-WP (Ø35 mm, Ø40 mm), 400-HR-WR (Ø35 mm, Ø40 mm).

ENGLISH

Order specifics	Finishes	Invoicing measure
For all articles: Article code Type of finish	Nylon .01 = White .02 = Biscuit .03 = Light Yellow .04 = Yellow .05 = Light Blue .06 = Blue .07 = Grey .08 = Green .09 = Red .10 = Black Stainless Steel AISI 316 L .44 = Satin finish .43 = Bright finish Wood standard finish: Beech custom finish: 📦	1 Linear meter

Structure of PBA article codes

0 0 0	.	0 0 0	.	0 0 0 0	.	0 0
Program		Progressive Code		Technical Specifications		Finish

Supplied with articulation curves. Programs 400-HR-WP (Ø35 mm, Ø40 mm), 400-HR-WR (Ø35 mm, Ø40 mm) excluded.

FRANCAIS

Caractéristiques de commande	Finitions	Mesure qui peut être facturée
Pour tous les articles: Code article Typologie de finition	Nylon .01 = Blanc .02 = Biscuit .03 = Jaune Pastel .04 = Jaune .05 = Bleu Pastel .06 = Bleu .07 = Gris .08 = Vert .09 = Rouge .10 = Noir Acier Inoxydable AISI 316 L .44 = Satiné .43 = Poli Bois teinte standard: Hêtre teinte sur échantillon: 📦	1 Mètre linéaire

Structure codes des articles PBA

0 0 0	.	0 0 0	.	0 0 0 0	.	0 0
Programme		Code Progressif		Spécifications Techniques		Finition

Fourni avec: courbes avec joint. A exception des Programmes 400-HR-WP (Ø35 mm, Ø40 mm), 400-HR-WR (Ø35 mm, Ø40 mm).

DEUTSCH

BESTELLANGABE	Ausführungen	In rechnung zu stellende grösse
Für alle Artikel: Artikelnummer Ausführung	Nylon .01 = Weiss .02 = Creme .03 = Blütengelb .04 = Gelb .05 = Fllederblau .06 = Blau .07 = Grau .08 = Grün .09 = Rot .10 = Schwarz Edelstahl WS 1.4404 .44 = Fein matt Satiniert .43 = Hochglanz poliert Massivholz Klarlack, mehrschichtung: Buche Lackierung nach Farbmuster: 📦	1 Linearmeter

Erläuterung zum PBA-Artikelcode

0 0 0	.	0 0 0	.	0 0 0 0	.	0 0
Programm		Artikelnummer		Spezifikation		Oberfläche / Farbe

Im Lieferumfang enthalten: Bögen mit variablem verstellbaren Winkel. Ausschliesslich Programmen 400-HR-WP (Ø35 mm, Ø40 mm), 400-HR-WR (Ø35 mm, Ø40 mm).

ESPAÑOL

Características del pedido	Acabados	Medida a facturar
Para todos los artículos: Código artículo Tipo de acabado	Nylon .01 = Blanco .02 = Biscuit .03 = Amarillo Pastel .04 = Amarillo .05 = Azul Pastel .06 = Azul .07 = Gris .08 = Verde .09 = Rojo .10 = Negro Acero Inoxidable AISI 316 L .44 = Satinado .43 = Brillante Madera barnizado en serie: Haya barnizado por muestra: 📦	1 Metro linear

Estructura códigos de artículos PBA

0 0 0	.	0 0 0	.	0 0 0 0	.	0 0
Programa		Código Progressivo		Características Técnicas		Acabado

Previstos en los equipos: curvas con articulación. Programas excluidos 400-HR-WP (Ø35 mm, Ø40 mm), 400-HR-WR (Ø35 mm, Ø40 mm).

NEDERLANDS

Besteiddetails	Afwerkingen	Afmeting te factureren
Voor alle artikelen: Artikelcode Afwerkingstype	Nylon .01 = Wit .02 = Biscuit .03 = Pastel Geel .04 = Geel .05 = Pastel Blauw .06 = Blauw .07 = Grijs .08 = Groen .09 = Rood .10 = Zwart Roestvast Staal AISI 316 L .44 = Mat geborsteld .43 = Blinkend geborsteld Hout standaard gekleurd: Beuk gekleurd volgen staal: 📦	1 Lopende meter

Structuur code artikels PBA

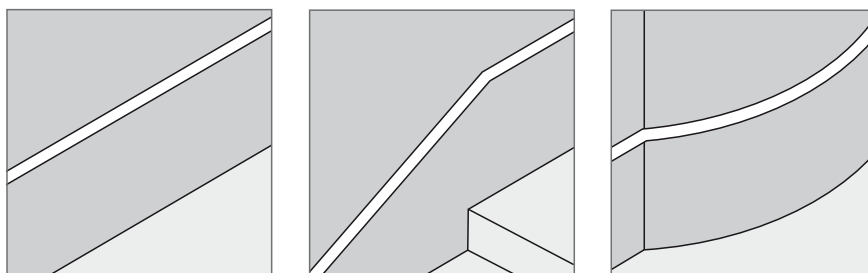
0 0 0	.	0 0 0	.	0 0 0 0	.	0 0
Programma		Toenemende Code		Technische Kenmerken		Afwerking

Bijgeleverd: buizen met bocht. Uitgezonderd de programma's 400-HR-WP (Ø35 mm, Ø40 mm), 400-HR-WR (Ø35 mm, Ø40 mm).



PHOTO: Fabio Zonta



PROGRAMMA 400-HR

PROGRAMMA 400-HR-NYD
Ø 36 mm
ITALIANO Corrimano in Poliammide con anima in alluminio

ENGLISH Polyamide handrail with aluminium core

FRANCAIS Main courante en Polyamide avec âme en aluminium

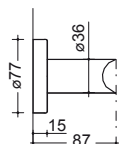
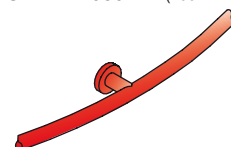
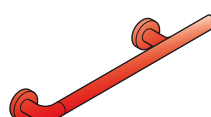
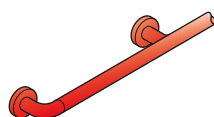
DEUTSCH Handlauf aus Polyamid mit Kern aus Aluminium

ESPAÑOL Barandilla de Poliamida con núcleo de aluminio

NEDERLANDS Leuning van Polyamide met aluminium kern

ART.
4CN.NYD.0002. ... (400NYD.002)

ART.
4CN.NYD.0102. ... (400NYD.102)

ART.
4CN.NYD.0301. ... (400NYD.301)

PROGRAMMA 400-HR-NYC
Ø 36 mm
ITALIANO Corrimano in Poliammide con anima in alluminio

ENGLISH Polyamide handrail with aluminium core

FRANCAIS Main courante en Polyamide avec âme en aluminium

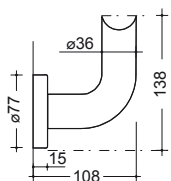
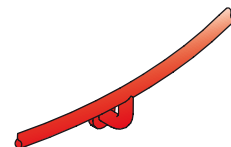
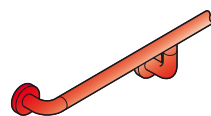
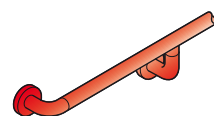
DEUTSCH Handlauf aus Polyamid mit Kern aus Aluminium

ESPAÑOL Barandilla de Poliamida con núcleo de aluminio

NEDERLANDS Leuning van Polyamide met aluminium kern

ART.
4CN.NYC.0002. ... (400NYC.002)

ART.
4CN.NYC.0102. ... (400NYC.102)

ART.
4CN.NYC.0301. ... (400NYC.301)

PROGRAMMA 400-HR-SSD
Ø 32 mm
ITALIANO Corrimano in Acciaio Inox AISI 316L

ENGLISH AISI 316L Stainless Steel handrail

FRANCAIS Main courante en Acier Inoxydable AISI 316L

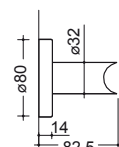
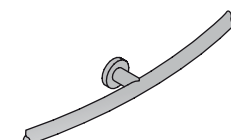
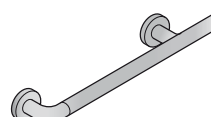
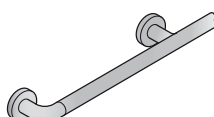
DEUTSCH Handlauf aus Edelstahl rostfrei Werkstoff 1.4404

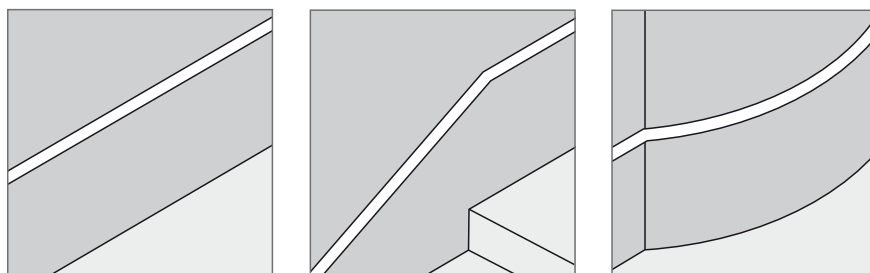
ESPAÑOL Barandilla de Acero Inoxidable AISI 316L

NEDERLANDS Leuning van Roestvrij Staal AISI 316L

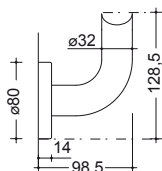
ART.
4CS.00D.0002. ... (400SSD.002)

ART.
4CS.00D.0102. ... (400SSD.102)

ART.
4CS.00D.0301. ... (400SSD.301)


PROGRAMMA 400-HR

PROGRAMMA 400-HR-SSC
Ø 32 mm

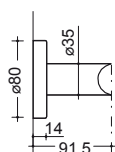
- ITALIANO** Corrimano in Acciaio Inox AISI 316L
- ENGLISH** AISI 316L Stainless Steel handrail
- FRANCAIS** Main courante en Acier Inoxydable AISI 316L
- DEUTSCH** Handlauf aus Edelstahl rostfrei Werkstoff 1.4404
- ESPAÑOL** Barandilla de Acero Inoxidable AISI 316L
- NEDERLANDS** Leuning van Roestvrij Staal AISI 316L



- | | | |
|--|--|--|
| ART.
4CS.00C.0002. ... (400SSC.002) | ART.
4CS.00C.0102. ... (400SSC.102) | ART.
4CS.00C.0301. ... (400SSC.301) |
| | | |

PROGRAMMA 400-HR-WSSD
Ø 35 mm

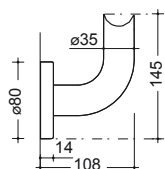
- ITALIANO** Corrimano in Legno con supporti in Acciaio Inox AISI 316L
- ENGLISH** Wooden handrail with AISI 316L Stainless Steel supports
- FRANCAIS** Main courante en Bois avec supports en Acier Inoxydable AISI 316L
- DEUTSCH** Handlauf aus Holz mit Halterungen aus Edelstahl rostfrei Werkstoff 1.4404
- ESPAÑOL** Barandilla de Madera con soportes de Acero Inoxidable AISI 316L
- NEDERLANDS** Leuning van Hout met steunen van Roestvrij Staal AISI 316L



- | | |
|---|--|
| ART.
4WS.00D.0002. ... (400WSSD.002) | ART.
4WS.00D.102. ... (400WSSD.102) |
| | |

PROGRAMMA 400-HR-WSSC
Ø 35 mm

- ITALIANO** Corrimano in Legno con supporti in Acciaio Inox AISI 316L
- ENGLISH** Wooden handrail with AISI 316L Stainless Steel supports
- FRANCAIS** Main courante en Bois avec supports en Acier Inoxydable AISI 316L
- DEUTSCH** Handlauf aus Holz mit Halterungen aus Edelstahl rostfrei Werkstoff 1.4404
- ESPAÑOL** Barandilla de Madera con soportes de Acero Inoxidable AISI 316L
- NEDERLANDS** Leuning van Hout met steunen van Roestvrij Staal AISI 316L

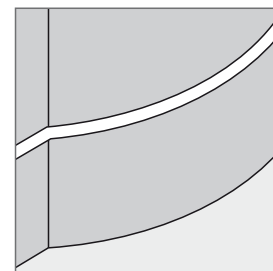
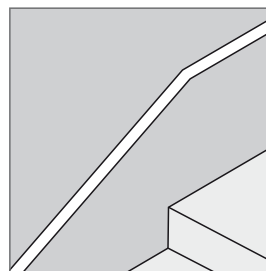
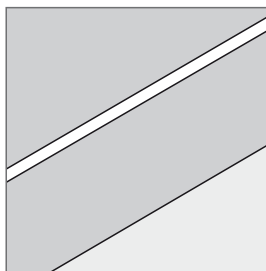


- | | |
|---|---|
| ART.
4WS.00C.0002. ... (400WSSC.002) | ART.
4WS.00C.0102. ... (400WSSC.102) |
| | |

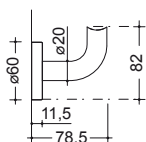
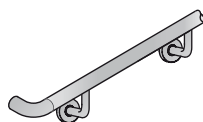
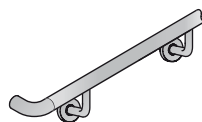
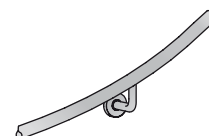


PHOTO: Fabio Zonta

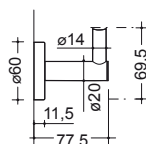
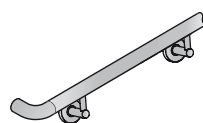
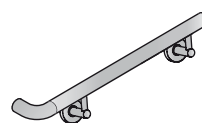
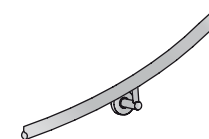


PROGRAMMA 400-HR

PROGRAMMA 400-HR-SSP
Ø 32 mm

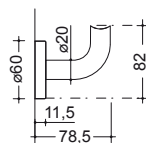
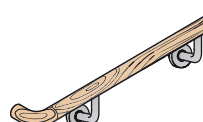
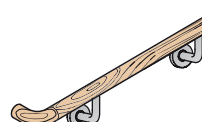
- ITALIANO** Corrimano in Acciaio Inox AISI 316L
- ENGLISH** AISI 316L Stainless Steel handrail
- FRANCAIS** Main courante en Acier Inoxydable AISI 316L
- DEUTSCH** Handlauf aus Edelstahl rostfrei Werkstoff 1.4404
- ESPAÑOL** Barandilla de Acero Inoxidable AISI 316L
- NEDERLANDS** Leuning van Roestvrij Staal AISI 316L

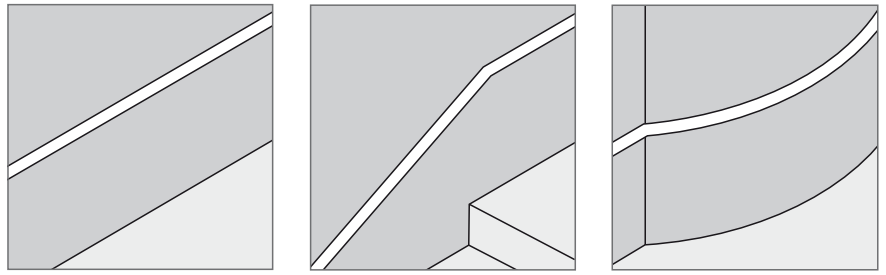
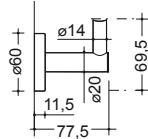

ART.
4CS.00P.0001. ... (400SSP.001)

ART.
4CS.00P.0101. ... (400SSP.101)

ART.
4CS.00P.0301. ... (400SSP.301)

PROGRAMMA 400-HR-SSR
Ø 32 mm

- ITALIANO** Corrimano in Acciaio Inox AISI 316L
- ENGLISH** AISI 316L Stainless Steel handrail
- FRANCAIS** Main courante en Acier Inoxydable AISI 316L
- DEUTSCH** Handlauf aus Edelstahl rostfrei Werkstoff 1.4404
- ESPAÑOL** Barandilla de Acero Inoxidable AISI 316L
- NEDERLANDS** Leuning van Roestvrij Staal AISI 316L


ART.
4CS.00R.0001. ... (400SSR.001)

ART.
4CS.00R.0101. ... (400SSR.101)

ART.
4CS.00R.0301. ... (400SSR.301)

PROGRAMMA 400-HR-WP
Ø 35 mm

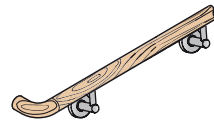
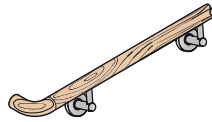
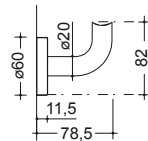
- ITALIANO** Corrimano in Legno con supporti in Acciaio Inox AISI 316L
- ENGLISH** Wooden handrail with AISI 316L Stainless Steel supports
- FRANCAIS** Main courante en Bois avec supports en Acier Inoxydable AISI 316L
- DEUTSCH** Handlauf aus Holz mit Halterungen aus Edelstahl rostfrei Werkstoff 1.4404
- ESPAÑOL** Barandilla de Madera con soportes de Acero Inoxidable AISI 316L
- NEDERLANDS** Leuning van Hout met steunen van Roestvrij Staal AISI 316L


ART.
4WP.001.0000. ... (400WP.001)

ART.
4WP.101.0000. ... (400WP.101)


PROGRAMMA 400-HR

PROGRAMMA 400-HR-WR
Ø 35 mm


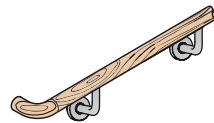
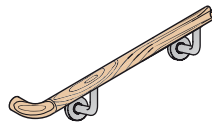
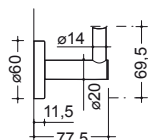
- ITALIANO** Corrimano in Legno con supporti in Acciaio Inox AISI 316L
- ENGLISH** Wooden handrail with AISI 316L Stainless Steel supports
- FRANCAIS** Main courante en Bois avec supports en Acier Inoxydable AISI 316L
- DEUTSCH** Handlauf aus Holz mit Halterungen aus Edelstahl rostfrei Werkstoff 1.4404
- ESPAÑOL** Barandilla de Madera con soportes de Acero Inoxidable AISI 316L
- NEDERLANDS** Leuning van Hout met steunen van Roestvrij Staal AISI 316L

ART.
 4WR.001.0000 ... (400WR.001)

ART.
 4WR.101.0000 ... (400WR.101)

PROGRAMMA 400-HR-WP
Ø 40 mm


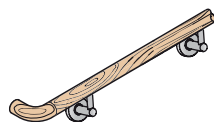
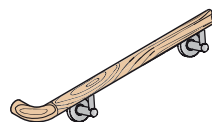
- ITALIANO** Corrimano in Legno con supporti in Acciaio Inox AISI 316L
- ENGLISH** Wooden handrail with AISI 316L Stainless Steel supports
- FRANCAIS** Main courante en Bois avec supports en Acier Inoxydable AISI 316L
- DEUTSCH** Handlauf aus Holz mit Halterungen aus Edelstahl rostfrei Werkstoff 1.4404
- ESPAÑOL** Barandilla de Madera con soportes de Acero Inoxidable AISI 316L
- NEDERLANDS** Leuning van Hout met steunen van Roestvrij Staal AISI 316L

ART.
 4WP.002.0000 ... (400WP.002)

ART.
 4WP.102.0000 ... (400WP.102)

PROGRAMMA 400-HR-WR
Ø 40 mm


- ITALIANO** Corrimano in Legno con supporti in Acciaio Inox AISI 316L
- ENGLISH** Wooden handrail with AISI 316L Stainless Steel supports
- FRANCAIS** Main courante en Bois avec supports en Acier Inoxydable AISI 316L
- DEUTSCH** Handlauf aus Holz mit Halterungen aus Edelstahl rostfrei Werkstoff 1.4404
- ESPAÑOL** Barandilla de Madera con soportes de Acero Inoxidable AISI 316L
- NEDERLANDS** Leuning van Hout met steunen van Roestvrij Staal AISI 316L

ART.
 4WR.002.0000 ... (400WR.002)

ART.
 4WR.102.0000 ... (400WR.102)


PROGRAMMA 400-HR

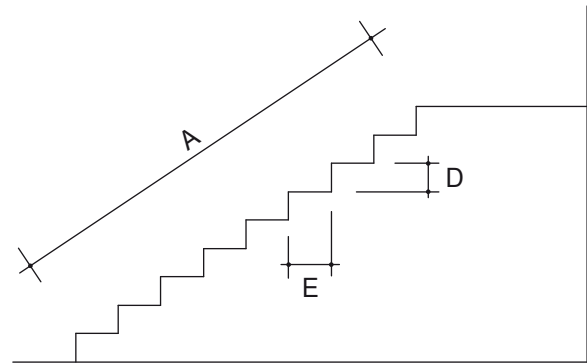
ISTRUZIONI RILIEVO MISURE SCALE - STAIR DIMENSION SURVEY INSTRUCTIONS - INSTRUCTION POUR LE LEVE DES MESURES DES ESCALIERS
 ANLEITUNG MESSUNG DER TREPPENABMESSUNGEN - INSTRUCCIONES MEDIDAS ESCALERAS - INSTRUCTIES OPMETINGEN TRAP

ITALIANO

Rappresentare la vista frontale e dall'alto della scala. Indicare il senso di salita, il numero di gradini, la misura inclinata da spigolo a spigolo (A), la misura del pianerottolo (B), il giro scala interno (C), l'alzata (D) e la pedata (E) del gradino.

ENGLISH

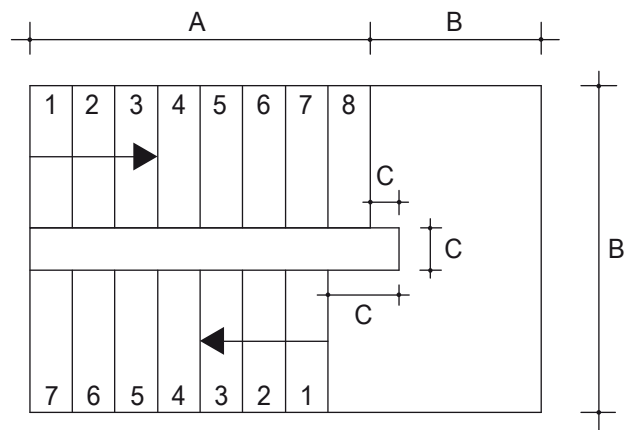
Draw a front view and a view from the top of the stairs. Indicate the direction of the stairs, the inclined measurement from corner to corner (A), the measurements of the landing (B), the inner turn measurement (C), and step height (D) and step depth (E).


FRANCAIS

Représenter une vue de face et une vue de dessus des escaliers. Indiquer le sens de la montée, le nombre de marches, la dimension de la pente d'une arête à l'autre (A), la dimension du palier (B), le rayon interne de la cage d'escaliers (C), l'élévation (D) et la largeur des marches.

DEUTSCH

Ansicht von vorne und von oben. Treppenaufrichtung, Anzahl der Treppenstufen, Neigung von Kante zu Kante (A), Größe des Treppenabsatzes (B), internen Treppenlauf (C), Treppensteigung (D) und Auftritte (E) der Stufe darstellen.


ESPAÑOL

Representar la vista frontal y por encima de la escalera. Indicar la dirección de subida, el número de escalones, la medida inclinada de arista a arista (A), la medida del descansillo (B), la rotación interna de la escalera (C), la contrahuella (D) y el peldaño (E) del escalón.

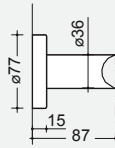
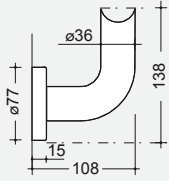
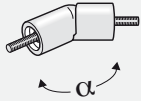
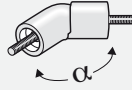
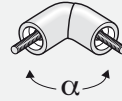
NEDERLANDS

Frontaal en bovenaanzicht van de trap weergeven. De richting van de trap aanduiden, het aantal tredes, de afmeting van trede tot trede (A), de afmeting van de overloop (B), de interne draairichting van de trap (C), de hoogte (D) en de diepte (E) van een trede.

PROGRAMMA 400-HR

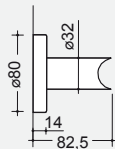
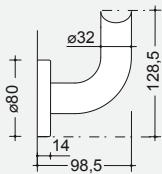
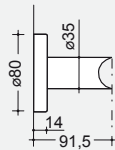
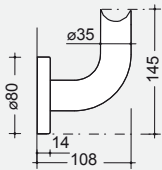
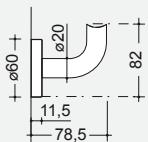
ELEMENTI COSTRUTTIVI - CONSTRUCTION ELEMENTS - ELEMENTS DE CONSTRUCTION BAUELEMENTE - ELEMENTOS CONSTRUCTIVOS - CONSTRUCTIE-ELEMENTEN

NYLON - NYLON - NYLON - NYLON - NYLON - NYLON

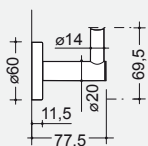

 Nylon, Nylon, Nylon
Nylon, Nylon, Nylon

 ART. 5CN.557.000V... (557/V)
 $\alpha = 0^\circ - 30^\circ$

 ART. 5CN.557.00VA... (557/VA)
 $\alpha = 30^\circ - 60^\circ$

 ART. 5CN.557.00VB... (557/VB)
 $\alpha = 60^\circ - 90^\circ$

 Nylon, Nylon, Nylon
Nylon, Nylon, Nylon

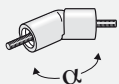
ACCIAIO INOX - STAINLESS STEEL - ACIER INOXYDABLE - ROSTFREIEM STAHL - ACERO INOXIDABLE - ROESTVAST STAAL


 Acciaio Inox, Stainless Steel,
Acier Inoxydable, Edelstahl rostfrei,
Acero Inoxidable, Roestvast Staal

 Legno, Wood, Bois
Holz, Madera, Hout

 Acciaio Inox, Stainless
Steel, Acier Inoxydable,
Edelstahl rostfrei,
Acero Inoxidable, Roestvast Staal

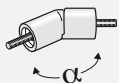
 Legno, Wood, Bois
Holz, Madera, Hout

 Legno, Wood, Bois
Holz, Madera, Hout

 Acciaio Inox, Stainless
Steel, Acier Inoxydable,
Edelstahl rostfrei,
Acero Inoxidable, Roestvast Staal

 Legno, Wood, Bois
Holz, Madera, Hout

 Legno, Wood, Bois
Holz, Madera, Hout


ART. 4CS.0SN.0000... (400-SS/SNV)


 Acciaio Inox, Stainless
Steel, Acier Inoxydable,
Edelstahl rostfrei,
Acero Inoxidable, Roestvast Staal


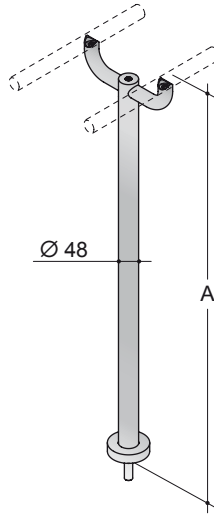
ART. 4CS.WSN.0000... (400-WSS/SNV)


 Legno, Wood, Bois
Holz, Madera, Hout

 Escluso - Excluded - A expection
- Ausschliesslich - Excludidos -
Uitgezonderd:
400-HR-WP (ø35 mm, ø40 mm)
400-HR-WR (ø35 mm, ø40 mm)

PROGRAMMA 400-HR-ST

ART. A

 4CS.ST1.0000. ... (400ST.001) 900
 4CS.ST1.9999. ... (400ST.001/A)

ITALIANO

Struttura portante per tratti piani e inclinati in Acciaio Inox AISI 316L.

ENGLISH

Handrail and supports for use on level and sloping surfaces in AISI 316L Stainless Steel.

FRANCAIS

Structure portante pour surfaces planes et inclinées en Acier Inoxydable AISI 316L.

DEUTSCH

Bodenstütze für Doppelhandlauf aus Edelstahl rostfrei Werkstoff 1.4404.

ESPAÑOL

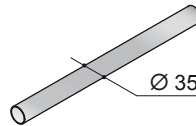
Estructura portante para secciones planas o inclinadas de Acero Inoxidable AISI 316L.

NEDERLANDS

Draagstructuur voor rechte en stijgende niveaus in roestvast staal AISI 316L.

ART.

4CS.ST2.0000. ... (400ST.002)


ITALIANO

Elemento corrimano diametro 35 mm in Acciaio Inox AISI 316L.

ENGLISH

Handrail 35 mm diameter in AISI 316L Stainless Steel.

FRANCAIS

Élément main-courante droit diamètre 35 mm en Acier Inoxydable AISI 316L.

DEUTSCH

Handlauf Durchmesser 35 mm aus Edelstahl rostfrei Werkstoff 1.4404.

ESPAÑOL

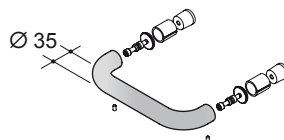
Elemento corremanos 35 mm de Acero Inoxidable AISI 316L.

NEDERLANDS

Buis voor handrail diametero 35 mm in Roestvast Staal AISI 316L.

ART.

4CS.ST3.0000. ... (400ST.003)


ITALIANO

Elemento iniziale e terminale per tratti piani in Acciaio Inox AISI 316L.

ENGLISH

Handrail end stops for use on level surfaces in AISI 316L Stainless Steel.

FRANCAIS

Élément de départ et final pour surfaces planes en Acier Inoxydable AISI 316L.

DEUTSCH

Endbögen aus Edelstahl rostfrei Werkstoff 1.4404.

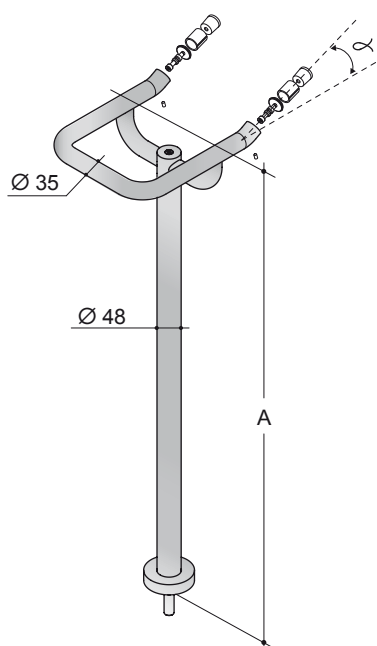
ESPAÑOL

Elemento inicial y terminal para secciones planas de Acero Inoxidable AISI 316L.

NEDERLANDS

Begin- en eindstop voor rechte niveaus in Roestvast Staal AISI 316L.

ART.	A
4CS.ST4.0000... (400ST.004)	900



ITALIANO

Elemento iniziale per scala in Acciaio Inox AISI 316L.

ENGLISH

Handrail end stops for use on stairs in AISI 316L Stainless Steel.

FRANCAIS

Elément de départ pour escaliers en Acier Inoxydable AISI 316L.

DEUTSCH

Endbögen für Treppenhandläufe aus Edelstahl rostfrei Werkstoff 1.4404.

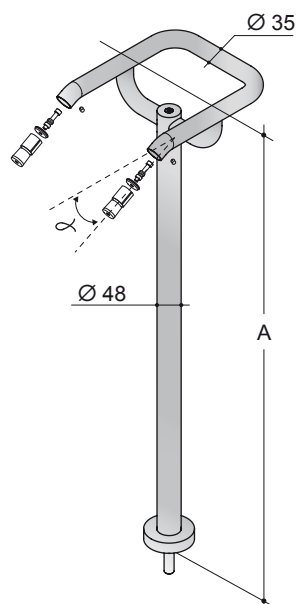
ESPAÑOL

Elemento inicial para escaleras de Acero Inoxidable AISI 316L.

NEDERLANDS

Begin voor trap in Roestvast Staal AISI 316L.

ART.	A
4CS.ST5.0000... (400ST.005)	900



ITALIANO

Elemento terminale per scala in Acciaio Inox AISI 316L.

ENGLISH

Handrail end stops for use on stairs in AISI 316L Stainless Steel.

FRANCAIS

Elément final pour escaliers en Acier Inoxydable AISI 316L.

DEUTSCH

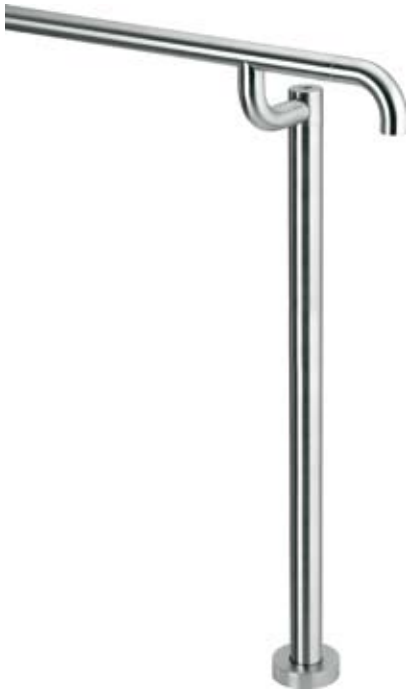
Endbögen für Treppenhandläufe aus Edelstahl rostfrei Werkstoff 1.4404.

ESPAÑOL

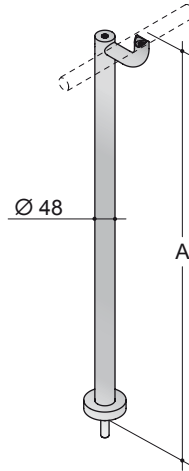
Elemento terminal para escaleras de Acero Inoxidable AISI 316L.

NEDERLANDS

Eindstop voor trap in Roestvast Staal AISI 316L.

PROGRAMMA 400-HR-ST

ART. A

4CS.ST6.0000... (400ST.006) **900**
 4CS.ST6.9999... (400ST.006/A)


ITALIANO

Struttura portante per tratti piani e inclinati in Acciaio Inox AISI 316L.

ENGLISH

Handrail and supports for use on level and sloping surfaces in AISI 316L Stainless Steel.

FRANCAIS

Structure portante pour surfaces planes et inclinées en Acier Inoxydable AISI 316L.

DEUTSCH

Bodenstütze für Doppelhandlauf aus Edelstahl rostfrei Werkstoff 1.4404.

ESPAÑOL

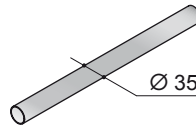
Estructura portante para secciones planas o inclinadas de Acero Inoxidable AISI 316L.

NEDERLANDS

Dragstructuur voor rechte en stijgende niveaus in roestvast staal AISI 316L.

ART.

4CS.ST2.0000... (400ST.002)


ITALIANO

Elemento corrimano diametro 35 mm in Acciaio Inox AISI 316L.

ENGLISH

Handrail 35 mm diameter in AISI 316L Stainless Steel.

FRANCAIS

Élément main-courante droit diamètre 35 mm en Acier Inoxydable AISI 316L.

DEUTSCH

Handlauf Durchmesser 35 mm aus Edelstahl rostfrei Werkstoff 1.4404.

ESPAÑOL

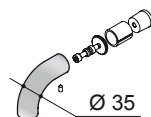
Elemento corremanos 35 mm de Acero Inoxidable AISI 316L.

NEDERLANDS

Buis voor handrail diametero 35 mm in Roestvast Staal AISI 316L.

ART.

4CS.ST7.0000... (400ST.007)


ITALIANO

Elemento iniziale e terminale per tratti piani in Acciaio Inox AISI 316L.

ENGLISH

Handrail end stops for use on level surfaces in AISI 316L Stainless Steel.

FRANCAIS

Élément de départ et final pour surfaces planes en Acier Inoxydable AISI 316L.

DEUTSCH

Endbögen aus Edelstahl rostfrei Werkstoff 1.4404.

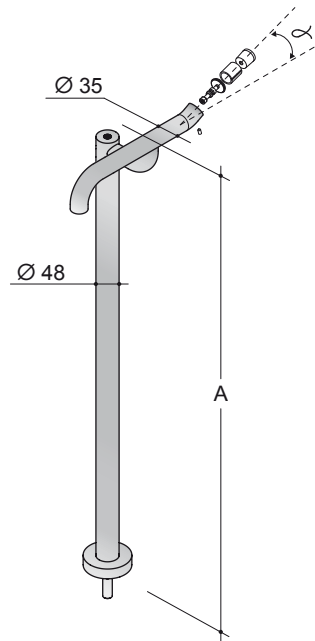
ESPAÑOL

Elemento inicial y terminal para secciones planas de Acero Inoxidable AISI 316L.

NEDERLANDS

Begin- en eindstop voor rechte niveaus in Roestvast Staal AISI 316L.

ART.	A
4CS.ST8.0000... (400ST.008)	900


ITALIANO

Elemento iniziale per scala in Acciaio Inox AISI 316L.

ENGLISH

Handrail end stops for use on stairs in AISI 316L Stainless Steel.

FRANCAIS

Elément de départ pour escaliers en Acier Inoxydable AISI 316L.

DEUTSCH

Endbögen für Treppenhandläufe aus Edelstahl rostfrei Werkstoff 1.4404.

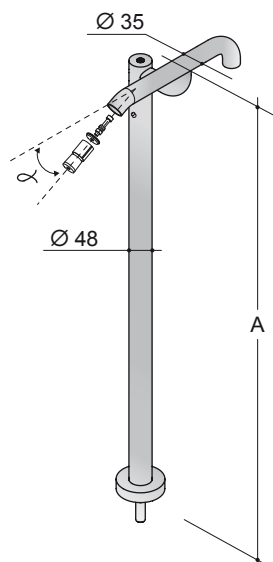
ESPAÑOL

Elemento inicial para escaleras de Acero Inoxidable AISI 316L.

NEDERLANDS

Begin voor trap in Roestvast Staal AISI 316L.

ART.	A
4CS.ST9.0000... (400ST.009)	900


ITALIANO

Elemento terminale per scala in Acciaio Inox AISI 316L.

ENGLISH

Handrail end stops for use on stairs in AISI 316L Stainless Steel.

FRANCAIS

Elément final pour escaliers en Acier Inoxydable AISI 316L.

DEUTSCH

Endbögen für Treppenhandläufe aus Edelstahl rostfrei Werkstoff 1.4404.

ESPAÑOL

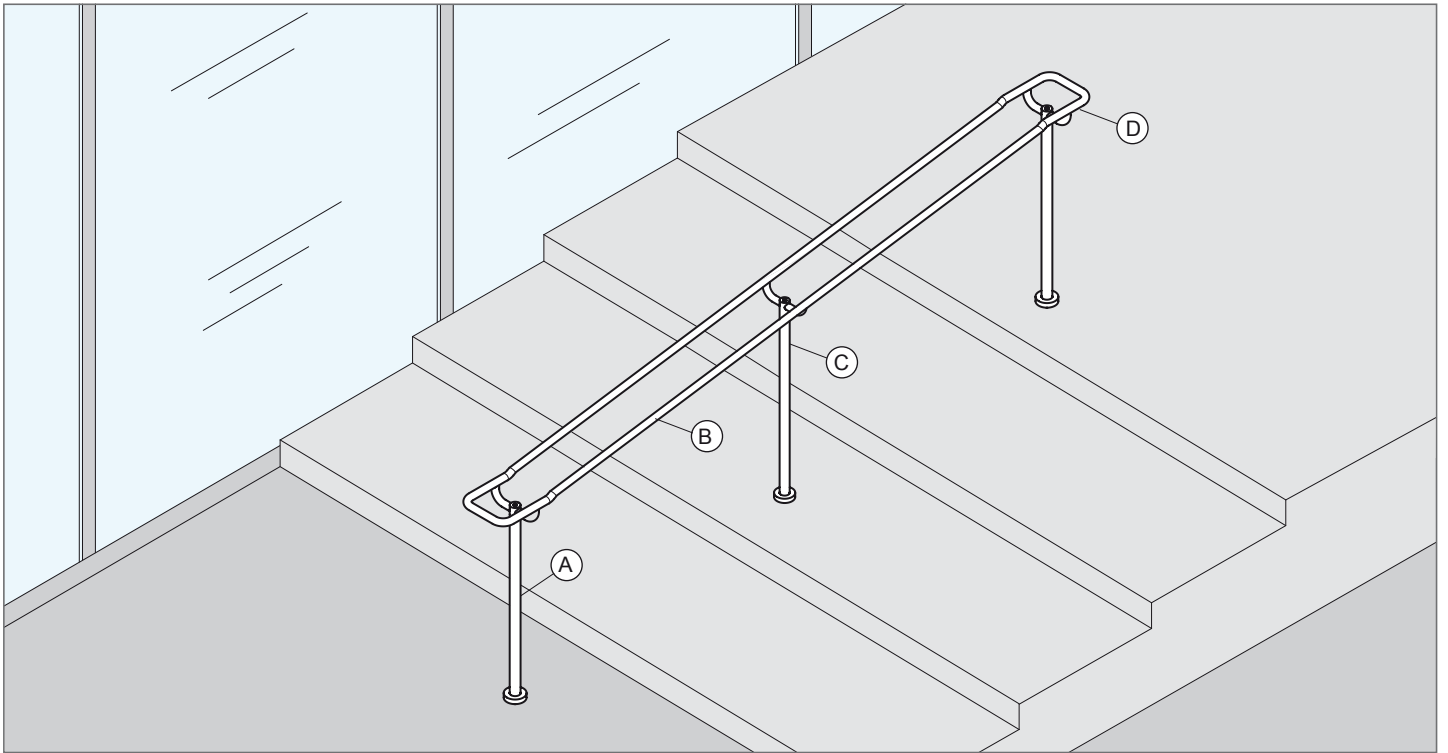
Elemento terminal para escaleras de Acero Inoxidable AISI 316L.

NEDERLANDS

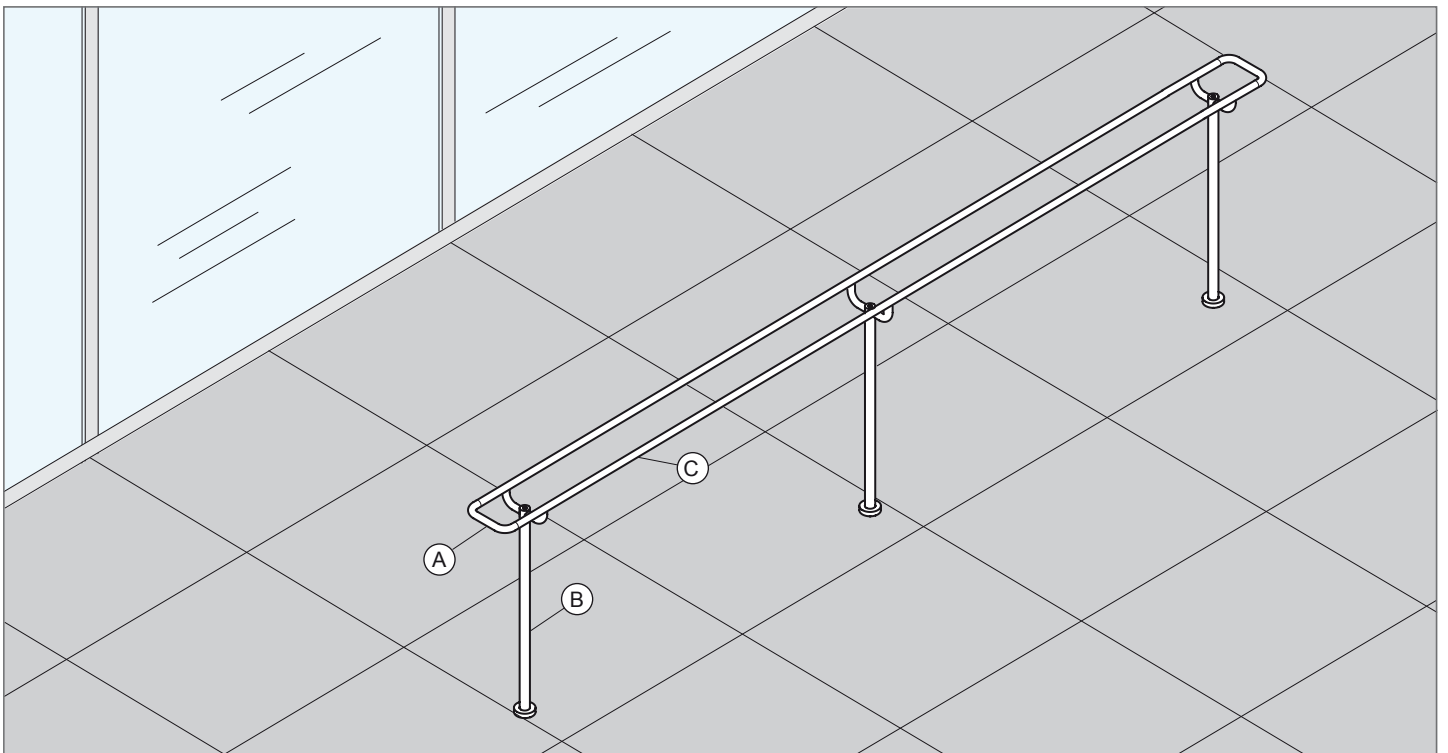
Eindstop voor trap in Roestvast Staal AISI 316L.

PROGRAMMA 400-HR-ST

GUIDA AL PROGETTO - GUIDE TO THE PROJECT - DESCRIPTIF PROJECT - PLANUNGSÜBERSICHT - GUIA AL PROYECTO - LEIDRAAD VOOR HET ONTWERP



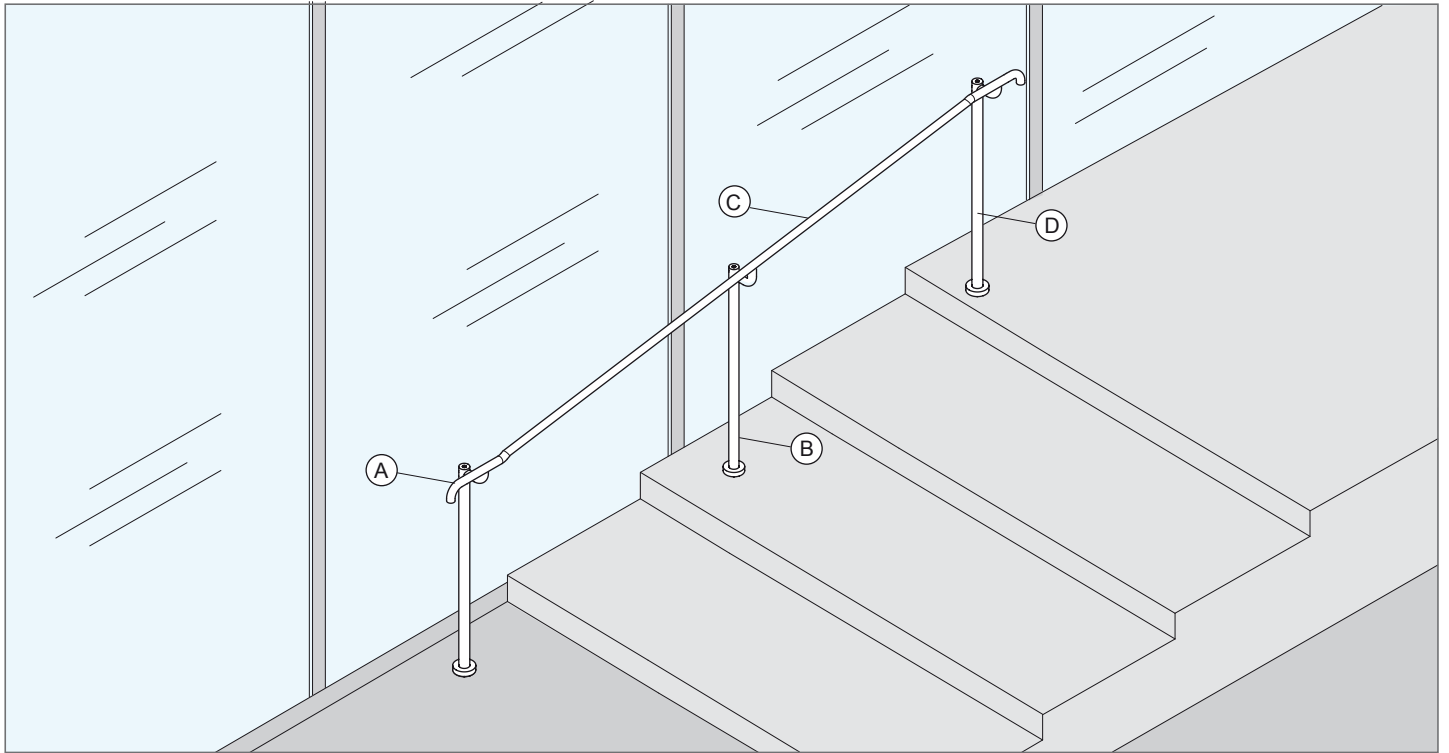
- (A) art. 4CS.ST4.0000 (400ST.004)
- (B) art. 4CS.ST2.0000 (400ST.002)
- (C) art. 4CS.ST1.0000 (400ST.001)
- (D) art. 4CS.ST5.0000 (400ST.005)



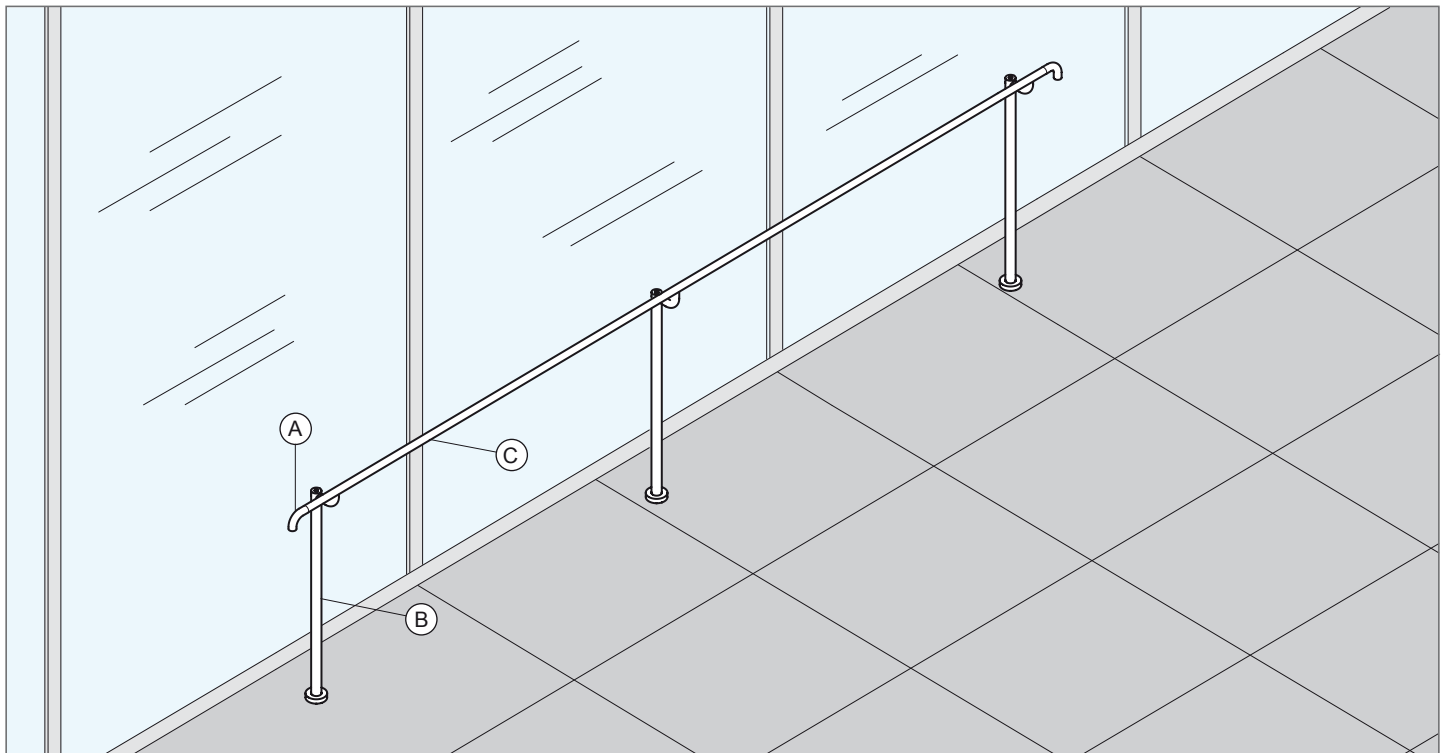
- (A) art. 4CS.ST3.0000 (400ST.003)
- (B) art. 4CS.ST1.0000 (400ST.001)
- (C) art. 4CS.ST2.0000 (400ST.002)

PROGRAMMA 400-HR-ST

GUIDA AL PROGETTO - GUIDE TO THE PROJECT - DESCRIPTIF PROJECT - PLANUNGSÜBERSICHT - GUIA AL PROYECTO - LEIDRAAD VOOR HET ONTWERP



- (A) art. 4CS.ST8.0000 (400ST.008)
- (B) art. 4CS.ST6.0000 (400ST.006)
- (C) art. 4CS.ST2.0000 (400ST.002)
- (D) art. 4CS.ST9.0000 (400ST.009)

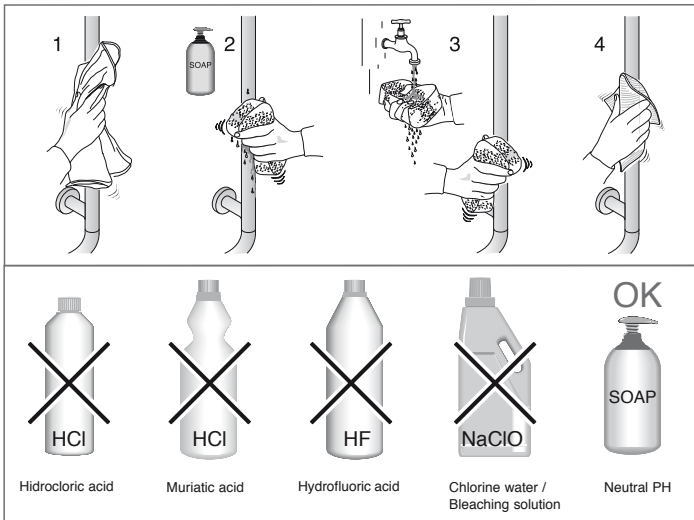
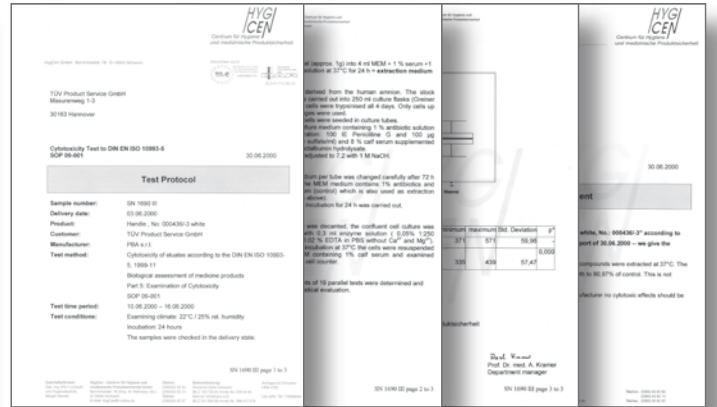
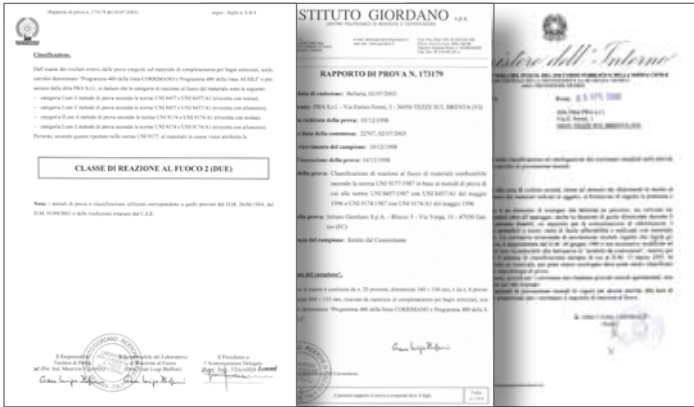


- (A) art. 4CS.ST7.0000 (400ST.007)
- (B) art. 4CS.ST6.0000 (400ST.006)
- (C) art. 4CS.ST2.0000 (400ST.002)

PROGRAMMA 400-HR

PROVE DI RESISTENZA AL FUOCO - FIRE-RESISTANCE PERFORMANCE
 ESSAI DA RÉSISTANCE AU FEU - FEUERWIDERSTANDSPRÜFUNG
 ENSAYO DE RESISTENCIA AL FUEGO - ATTESTEN VOOR BRANDWEERSTAND

TEST CITOTOSSICITÀ - CITOTOXICITY TEST - TEST DE CYTOTOXICITÉ
 ZYTOTOXIZITÄTSPRÜFUNG - PRUEBA DE CITOTOXICIDAD
 CYTOTOXISCHE TEST



ITALIANO
 Consigli per una corretta pulizia dei prodotti in Resina Poliammidica. Per la pulizia dei prodotti non utilizzare: detersivi o sostanze contenenti cloroformio, cloruro di metilene, cloro, acidi anche a bassa concentrazione, bromo, cresolo, fenolo, formaldeide, formalina e permanganato di potassio.

ENGLISH
 Advice for a correct maintenance of the products in Polyamide Resin. For cleaning PBA Nylon, please do not use soaps or detergents containing chloroform, chloride water, chlorine, acids, bromine, cresol, carbolic acid, formaldehyde, formalin or potassium permanganate regardless of percentage content.

FRANCAIS
 Conseils pour un nettoyage correct des produits en Résin Polyamide. Pour le nettoyage du nylon ne pas utiliser les produits suivants : détergents ou substances contenant du chloroforme, chlorure de méthylène, chlore, acides - même a faible concentration de brome, crésol, phénol, formaldéhyde, formaline et permanganate de potassium.

DEUTSCH
 Ratschläge für eine korrekte reinigung der produkten aus polyamidharz. Zum Reinigen folgende Produkte nicht verwenden: Reinigungsmittel oder Substanzen welche folgende Zusätze enthalten: Chloroform, Chloror -Methyl, Chlor, Säuren auch in geringer Konzentration, Brom, Kresol, Phenol, Formaldehyd, Formalin sowie Kalium Permanganat.

ESPAÑOL
 Consejos para una correcta limpieza de los productos en Resina de Poliamida. Para la limpieza de los productos no utilicen: detergentes o sustancias que contienen cloroformo, cloruro de metileno, cloro, acidos - incluye en bajas concentraciones, bromo, cresol, fenol, formaldehido, formalina y permanganato de potasio.

NEDERLANDS
 Raadgevingen voor een correct onderhoud van Nylon producten. Gelieve voor de reiniging van onze producten de volgende zaken NIET te gebruiken : detergenten of substanties die de volgende elementen bevatten : chloroform, metleenchlorure, chlor, alle zuren zelfs in lage concentraties, broom, formaldehyde, cresolen, fenolen, formaline en kaliumpermanganaat.

MATERIALI IMPIEGATI - MATERIALS - MATÉRIAUX UTILISÉS - VERWENDETE MATERIALEN - MATERIALES EMPLEADOS - GEBRUIKTE MATERIALEN

ITALIANO
NYLON
 • Resina termoplastica (Poliamide 6).
 • Alta resistenza meccanica.
 • Tenacità agli urti.
 • Resistenza ad usura e abrasione.
 • Comportamento antistatico, buon potere di isolamento elettrico e buona resistenza alle correnti striscianti.
 • Buona stabilità ad agenti chimici quali idrocarburi, oli, grassi e buona resistenza a numerosissimi agenti chimici come per esempio solventi, detersivi e disinfettanti.
 • Scarsa conducibilità termica.
 • Classificata come auto-estinguibile di categoria UL 94V-2 e non emana gas tossici.
 • È fisiologicamente innocuo.
 • Non contiene Cadmio, Piombo, Mercurio e Selenio e viene prodotta senza metalli pesanti o loro derivati.

ALLUMINIUM
 • Robustezza meccanica.
 • Straordinaria leggerezza.
 • Buona resistenza alla corrosione.
 Per informazioni più dettagliate sui materiali vedere opuscolo allegato al prodotto.

ENGLISH
NYLON
 • Thermoplastic resin (Polyamide 6).
 • High mechanical resistance.
 • Tenacity.
 • Resistance to wear and abrasion.
 • Antistatic, with good insulating power and good resistance to creeping currents.
 • Good stability to chemical agents such as hydrocarbons, oils and fats; good resistance to numerous chemical agents such as solvents, detergents and disinfectants.
 • Poor thermal conduction.
 • Classified as self-extinguishable into category UL 94V-2. It does not generate toxic gases.
 • Physiologically innocuous.
 • It is Cadmium, Lead, Mercury and Selenium free and is produced without heavy metal or its derivatives.

ALLUMINIUM
 • Mechanical strength.
 • Extraordinary lightness.
 • Good resistance to corrosion.
 For more detailed information about the materials please see the brochure attached to the product.

FRANCAIS
NYLON
 • Résine thermoplastique (Polyamide 6).
 • Résistance mécanique élevée.
 • Grande résistance aux chocs.
 • Résistance à l'usure et à l'abrasion.
 • Comportement antistatique, bon pouvoir d'isolation électrique et bonne résistance aux courants rampants.
 • Bonne stabilité aux agents chimiques, tels que les hydrocarbures, les huiles et les graisses et bonne résistance aux nombreux agents chimiques tels que les solvants, les détergents et les désinfectants.
 • Faible conductivité thermique.
 • Classée comme auto-extinguible de catégorie UL 94V-2, ne libère pas de gaz toxiques.
 • Physiologiquement inoffensif.
 • Ne contient ni cadmium, ni plomb, ni mercure, ni sélénium ; est produit sans métaux lourds ni dérivés.

ALUMINIUM
 • Robustesse mécanique.
 • Extraordinaire légèreté.
 • Bonne résistance à la corrosion.
 Pour en savoir davantage sur les matériaux utilisés, consultez le document joint au produit.

DEUTSCH
NYLON
 • Thermoplastisches Harz (Polyamid 6).
 • Hohe mechanische Widerstandsfähigkeit.
 • Unzerstörbar gegenüber üblichen Schlagbeanspruchungen.
 • Widerstandsfähigkeit gegen Verschleiss und Abnutzung durch Reibung.
 • Antistatisch, gutes Isoliervermögen und gute Widerstandsfähigkeit gegen den elektrischen Strom.
 • Beständigkeit gegen chemische Mittel wie Kohlenwasserstoffe, Öle und Fette und gegen zahlreiche chemische Mittel wie z.B. Lösungsmittel, Reinigungsmittel und Desinfektionsmittel.
 • Geringe Wärmeleitfähigkeit.
 • Selbstverlöschend in der Kategorie UL 94 V-2 klassifiziert. Es entstehen keine toxischen Gase.
 • Physiologisch unschädlich.
 • Frei von Cadmium, Blei, Quecksilber und Selen. Ohne Schwermetalle oder Abkömmlingen hergestellt.

ALUMINIUM
 • Mechanische Widerstandsfähigkeit.
 • Aussergewöhnliche Leichtigkeit.
 • Gute Korrosionsbeständigkeit.
 Für weitere Informationen über die Materialien sehen Sie das mit dem Produkt beiliegende Dépliant.

ESPAÑOL
NYLON
 • Resina de termoplástico (Poliamida 6).
 • Alta resistencia mecánica.
 • Resistencia contra impactos.
 • Resistencia a desgaste y abrasión.
 • Comportamiento antiestático, buen poder de aislamiento eléctrico y buena resistencia a corrientes de arrastre.
 • Buena estabilidad a agentes químicos como hidrocarburos, aceites, grasas y buena resistencia a numerosos agentes químicos, como, por ejemplo, disolventes, detergentes y desinfectantes.
 • Escasa conductibilidad térmica.
 • Clasificada como auto-extinguible de clase UL 94V-2 y no emana gas tóxicos.
 • Es fisiológicamente inocuo.
 • No contiene cadmio, plomo, mercurio y selenio y se produce sin metales pesados o sus derivados.

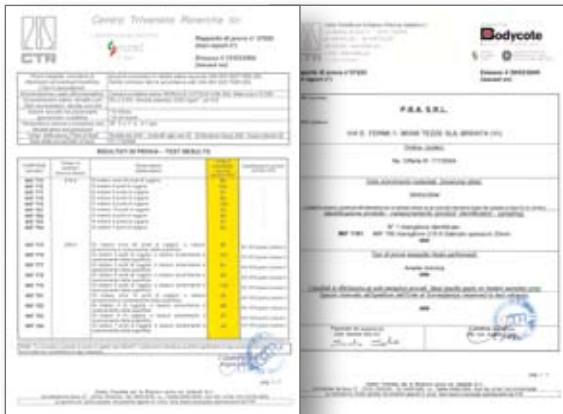
ALUMINIO
 • Robustez mecánica.
 • Extraordinaria ligereza.
 • Buena resistencia a corrosión.
 Para informaciones más detalladas sobre materiales ver folleto anexo al producto.

NEDERLANDS
NYLON
 • POLYAMIDE 6 (thermoplastische kunststof)
 • Hoge mechanische weerstand stoelvast
 • Gebruiks vriendelijk en onderhoudsvriendelijk
 • Antistatisch, goed elektrisch isolerend vermogen en goede weerstand ten opzichte van olie, vetten en een heel goede weerstand ten opzichte van heel veel chemische agenten zoals bv. solventen, detergenten en desinfecteermiddelen.
 • Laag thermisch geleidingsvermogen
 • Geklasseerd als zelfdovend onder categorie UL94V-S
 • Produceert geen giftige gassen
 • Is fysiologisch onschadelijk
 • Bevat geen cadmium, lood, kwik of selenium en wordt geproduceerd zonder zware metalen of hun derivaten

ALUMINIUM
 • Hoge mechanische weerstand
 • Uitzonderlijke licht in gewicht
 • Goede roestbestendigheid
 Voor meer gedetailleerde informatie over de gebruikte materialen, lees de brochure in bijlage over het product.

PROGRAMMA 400-HR

CERTIFICAZIONE MATERIALE - MATERIAL CERTIFICATION - CERTIFICATION DU MATÉRIEL - ZERTIFIZIERUNG DES MATERIALS
 CERTIFICACIÒN DEL MATERIAL - CERTIFIËRING VAN HET MATERIAAL


ITALIANO

L'acciaio usato da **pba**, Acciaio Inox AISI 316L (1), garantisce il massimo grado di resistenza alla corrosione: normativa di riferimento UNI EN 1670; certificazione ottenuta dopo test di corrosione in nebbia salina secondo UNI ISO 9227.
 (1) X2CrNiMo 17-12-2 secondo designazione EN 10088-3

ENGLISH

The AISI 316L Stainless Steel (1) steel used by **pba**, meets the requirements of UNI EN 1670, the ultimate quality standard for ensuring resistance to corrosion. **Pba** has been awarded a certificate for successfully salt spray testing the stainless steel in accordance with UNI ISO 9227.
 (1) X2CrNiMo 17-12-2 as per EN 10088-3

FRANCAIS

L'acier utilisé par **pba**, Acier Inoxydable AISI 316L (1), garantit le degré maximum de résistance à la corrosion : norme de référence UNI EN 1670; certification obtenue après un essai de corrosion par exposition à un brouillard salin conformément à UNI ISO 9227.
 (1) X2CrNiMo 17-12-2 conforme à la désignation EN 10088-3

DEUTSCH

Das **pba** Edelstahl rostfrei Werkstoff 1.4404 (1) ist korrosionsbeständig (die höchste Stufe in Bezug auf die Norm UNI EN 1670). Die Zertifizierung wurde nach erfolgreich bestanden Korrosionstesten in Salznebel gemäß UNI ISO 9227 ausgestellt.
 (1) X2CrNiMo 17-12-2 gemäss EN 10088-3

ESPAÑOL

El acero utilizado por **pba**, Acero Inoxidable AISI 316L (1), garantiza el grado máximo de resistencia a la corrosión: Normativa UNI EN 1670; certificación obtenida después de una prueba de resistencia contra corrosión en atmósfera de neblinas salinas según los estándares UNI ISO 9227.
 (1) X2CrNiMo 17-12-2 como en EN 10088-3

NEDERLANDS

Labotests hebben aangetoond dat **pba** deurkrukken van de serie 200-2000 in Roestvast Staal AISI 316L (1) een uitermate hoge roestweerstand garanderen (graad 4 – de hoogst bereikbare graad voor de Europese norm UNI EN 1670). Het certificaat wordt toegekend na weerstandstests in de zoutnevels, uitgevoerd volgens de normering UNI ISO 9227.
 (1) X2CrNiMo 17-12-2 volgens de norm EN 10088-3

MATERIALI IMPIEGATI - MATERIALS - MATÉRIAUX UTILISÉS - VERWENDETE MATERIALEN - MATERIALES EMPLEADOS - GEBRUIKTE MATERIALEN

Chemical compositions of AISI Stainless Steel grades

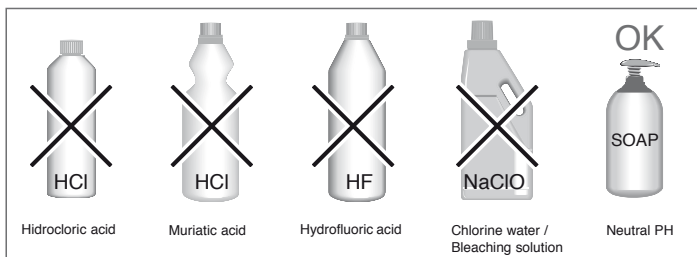
Material - Stainless Steel	C %	Cr %	Ni %	Mo %
AISI 430 (1.4016)	0,12 max	14.0-18.0	/	/
AISI 304 (1.4301)	0,08 max	18.0-20.0	8.0-10.5	/
AISI 316 (1.4401)	0,08 max	16.0-18.0	10.0-14.0	2.00-3.00
AISI 316L (1.4404)*	0,03 max	16.0-18.0	10.0-14.0	2.00-3.00

*Standard Pba

Estimated pit corrosion time – time to penetrate 1 mm (years) by steel type c

Location - Stainless Steel	Marine	Semi-industrial	Rural
Stainless Steel AISI 430 (1.4016)	N/A	85	250
Stainless Steel AISI 304 (1.4301)	145	135	770
Stainless Steel AISI 316 (1.4401)	260	525	1200

Source: The British Stainless Steel Association [BSSA]


ITALIANO

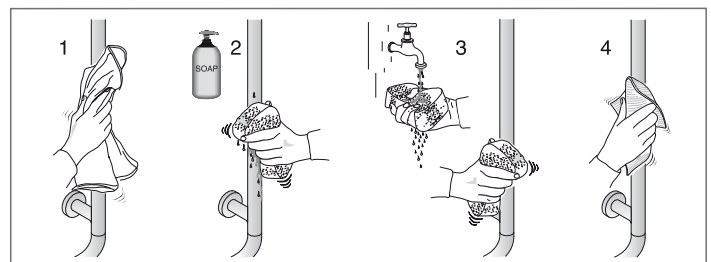
Consigli per una corretta pulizia dei prodotti in Acciaio Inox

ENGLISH

Advice for a correct maintenance of the products in Stainless Steel

FRANCAIS

Conseils pour un nettoyage correct des produits en Acier Inoxydable


DEUTSCH

Ratschläge für eine korrekte reinigung der produkten aus Edelstahl Rostfrei

ESPAÑOL

Consejos para una correcta limpieza de los productos de Acero Inoxidable

NEDERLANDS

Raadgevingen voor een correct onderhoud van Roestvast Staal producten

PBA S.p.A.
Via Enrico Fermi, 1 - I-36056 Tezze sul Brenta (VI)
Tel. +39 0424 5451 - Fax +39 0424 545222
e-mail: info@pba.it - www.pba.it

PBA Deutschland GmbH
Raiffeisenstraße, 4a - D-83607 Holzkirchen
Tel. +49 8024 608140 - Fax +49 8024 6081420
e-mail: info@de.pba.it - www.pba.it